



Information Day of the cPPPs

Brussels 21st October 2014

**European Green Vehicle Initiative
in Horizon 2020
Work programme 2015**



**A joint presentation by Project Officers of
DG RTD & DG CONNECT**



EGVI
European Green
Vehicles Initiative



Electromobility: What is at stake?

Electro-mobility is one of the largest opportunities to radically change the transport system & make a quantum leap into the next generation of sustainable mobility

- **Reduce emissions** - sustainable growth capacity
- **Energy independence** (less dependence on fossil energy)
- **Competitiveness of EU automotive** sector
- Competitiveness/innovation of **EU electronics industry**

More than 13 million jobs!



EGVI
European Green
Vehicles Initiative



European Green Cars Initiative PPP



What:

One of the three Recovery Plan (2008) PPPs

Main RTD priorities:

Electrification of road and urban transport;

Improved energy efficiency for heavy-duty vehicles;

Logistics and co-modality

Funding:

Up to € 500 million for research



EGVI
European Green
Vehicles Initiative



European Green Cars Initiative PPP



Industrial Advisory Group



Members (also representing ETPs ERTRAC, EPoSS, SmartGrids, EIRAC):

AVL – Bosch – Continental – ECT – FEV - Fiat Research Center – Iberdrola – IFP - KU Leuven - Procter & Gamble – PTV – Renault – Ricardo – Schachinger – Siemens – Valeo - VDI/VDE-IT – Volkswagen – Volvo

+

DG RTD - DG INFSO/CONNECT - DG MOVE - DG ENVI - DG ENTR - EIB



European Green Cars Initiative PPP



115 projects, of which around 95 on electrification
Almost complete coverage of the EGCI roadmap

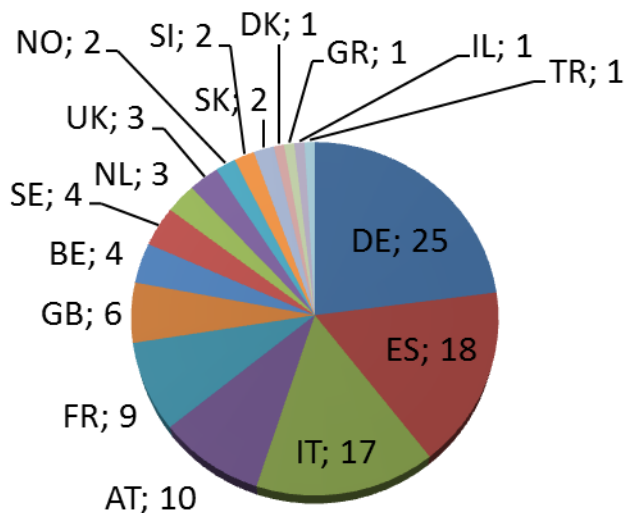

EC contribution in € million

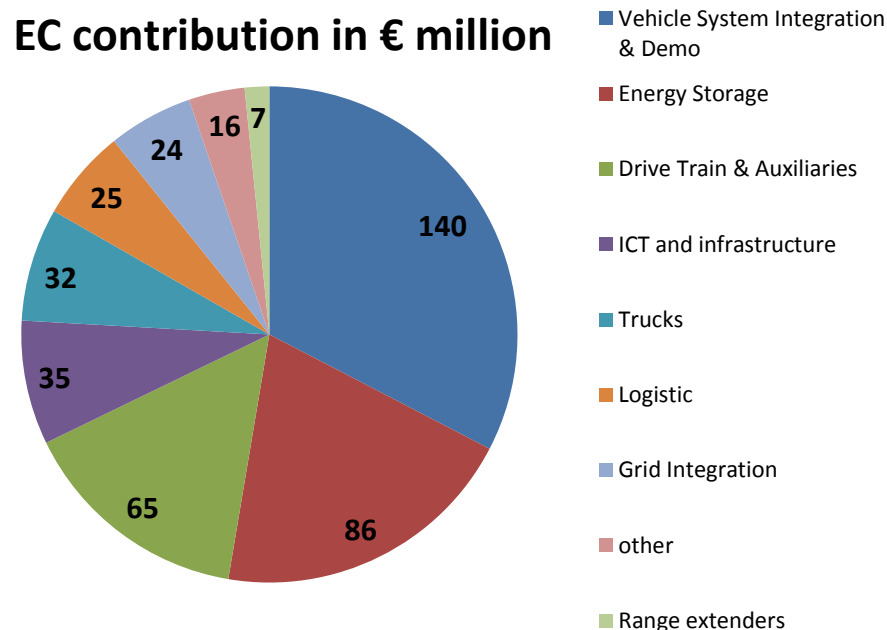

Member State participation

WIDE-MOB

Mission:

Building blocks concepts for efficient and safe multiuse urban electrical vehicles

Focus:

- Development of state-of-the-art building blocks critical systems
- Demonstrate and validate the integration of the developed systems into a next generation low weight and safe Electrical Vehicles for urban mobility

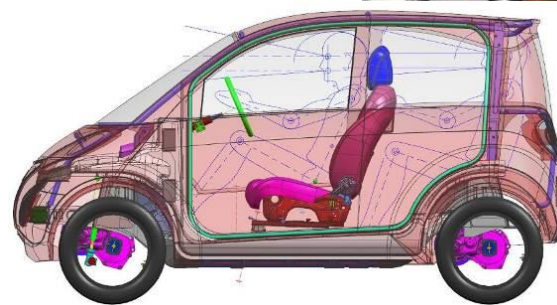

Research Topics and results:

- Exceptional crashworthy performance for such small vehicle demonstrated
- Improved aerodynamics
- Embedded solar panels distributed on both horizontal and vertical surfaces with adaptive electronics ensuring ~20 km/d free
- Modular and reconfigurable design addressing the WIDest needs with ergonomic on board space
- Distributed fail safe propulsion (before Tesla) with symmetric powered axles

Coordinator: Fiat
Research Center
Total budget: 3,9M€
EC contribution: 2,6M€
Start date: 1/12/2010
Duration: 36 months

EUNICE

Mission:

Eco-design and Validation of a new generation of motor in-Wheel Concept for Electric Vehicles

Focus:

- New “motor in wheel” solution for “B segment” electric vehicles
- Robustness and safety, with high power density for equivalent ICE performance (52kW continuous operation, 100kW peak)
- Compatible with existing platforms with minimum changes

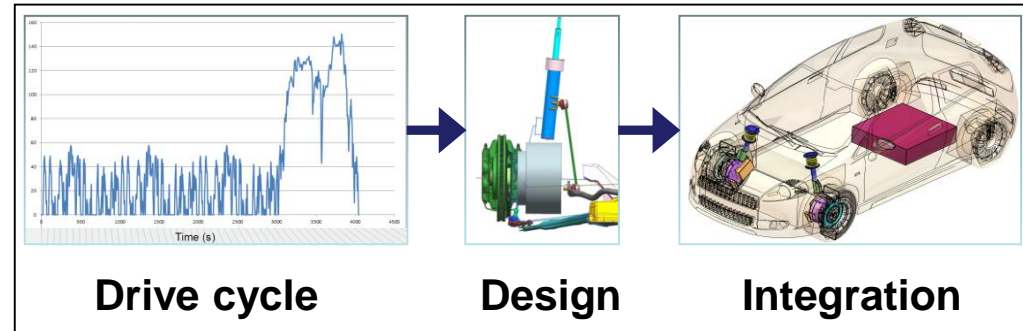

Research Topics and results:

- **Functional requirement definition:**
 - Interfaces between partners being defined
 - Torque- Speed characteristic for high performance & drivability
 - Definition of vehicle dynamics targets
- **Integration on a McPherson suspension type:**
 - Research in highly integrated topologies
 - Thermo mechanical constraints definition
- **First feasibility go-no go milestone to be assessed soon**

Coordinator: Tecnalía
Total budget: 4,8M€
EC contribution: 2,9M€
Start date: 1/9/2012
Duration: 36 months

Mission:

"Next Generation High Efficiency Motors and Power Trains"

Focus:

- Innovative Technologies for Integrated FEV/HEV platforms
- Innovative magnetic machine technologies
- Safety first adaptive electronic controllers
- New standards and guidelines for uptake of FEV/HEV

Coordinator: University of Cambridge

Total costs: ± 3.5m€

EC contribution: 2.4m€

Start date: 1/12/2010

Duration: 36 months

Research Topics:

- **Novel Magnetic Materials**
 - **Nanoscale modelling & simulation**
 - **New nano-macro production methods**
 - **Excellent results, better magnetic performance with just 10% of Dy**
- **Innovative Motor Designs**
 - **New topologies for high efficiency**
 - **New controller systems and technology**
 - **Multi-physics modelling and simulation**
- **Power Controllers**
 - **Fault-tolerant adaptive electronic controllers**
 - **Efficient bidirectional power coupling between the drive and accumulator pack**

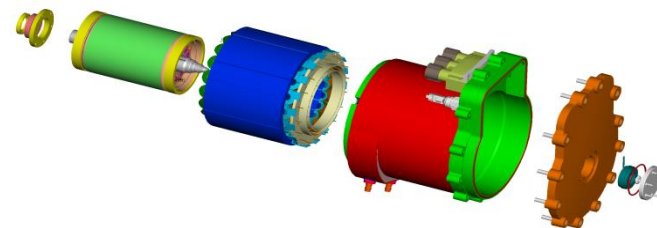

GREENLION

Mission:

Manufacturing processes for greener and cheaper Li-Ion batteries (electrodes, cells & modules)

Focus:

- More environmentally friendly production of battery components
- Substantial shortening of the battery assembly procedures: automated module assembly
- Easier and more effective disassembly and end-of-life recycling

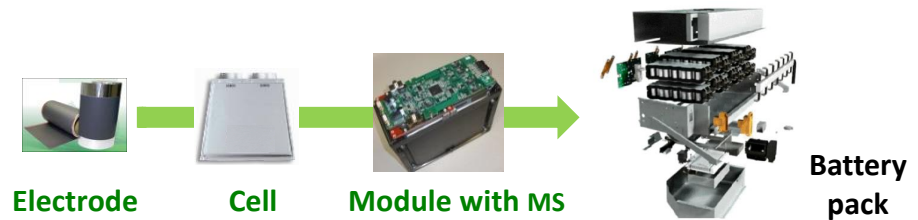

Research Topics and results:

- **Aqueous processing of ELECTRODES using natural binders**
 - 0.5 m² Graphite & NMC with CMC
- **CELL assembly**
 - GEN0 (C/LFP) and GEN1 (C/NMC; 1.5Ah)
 - GEN2 power cell design
- **Lighter MODULE design for automated assembly & easier disassembly coupled to GEN2 (ongoing)**

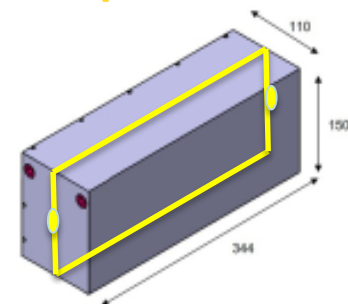
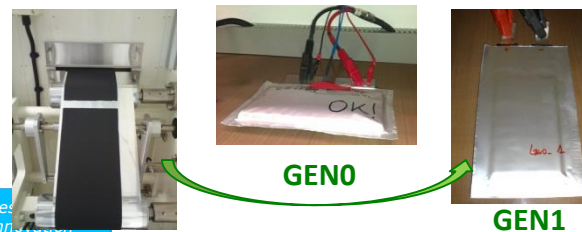

Coordinator: IK4-CIDETEC
 Total costs: 8,6M€
 EC contribution: 5,6M€
 Start date: 1/11/2011
 Duration: 48 months

SMARTOP

Mission:

to develop an autonomous smart roof for EVs integrating solar cells, storage systems and auxiliaries such as thermoelectric climatic control, electrochromic glazing, and courtesy LED lighting to increase comfort and fuel economy

Focus:

- New flexible lightweight solar panels (DSSC, back contact c-Si)
- Peltier modules based on high efficiency thermoelectric materials
- Smart integration of Li-batteries, EC glasses, LED lights and electronic management

Research Topics and results:

- Design of a modular roof component with energy generation and storage up to 1200 Wh per day
- Development of innovative and high performances sub-systems for power management
- Development of low cost, compact, low power consumption and robust electrified comfort auxiliaries

PV panel



DSSC

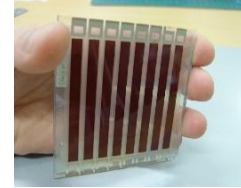

Battery pack and power management

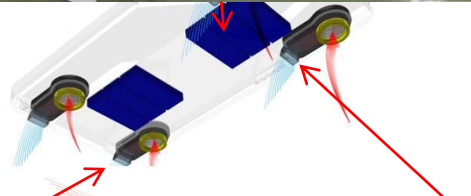
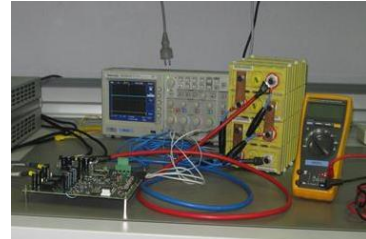

TE module



LED lighting

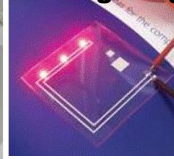

Coordinator: Fiat Research Center
 Total costs: 3,9M€
 EC contribution: 2,6M€
 Start date: 1/12/2010
 Duration: 36 months

ENLIGHT

Mission:

Development of highly innovative lightweight material technologies for structural parts of electric vehicles

Focus:

- highly innovative lightweight / low embedded CO₂ materials such as thermoplastics or bio-based materials,
- Manufacturing and joining capabilities for affordable medium-volume lightweight EVs.
- Design capabilities for affordable medium-volume lightweight EVs

Coordinator:
Fraunhofer LBF
Total costs: 10,9M€
EC contribution: 7,1M€
Start date: 1/10/2012
Duration: 48 months

Research Topics and results:

- **Conceptual lightweight design of defined modules of an advanced electric vehicle architecture with respect to weight and CO₂ balance over life-time**
- **Development of highly advanced materials to a stage that they are applicable at least in medium volume production; considered are thermoplastic and fibre reinforced composites, advanced hybrid (Al/CFRP) and sandwich materials, bio-materials**
- **Manufacturing processes for these materials for medium-scale production**

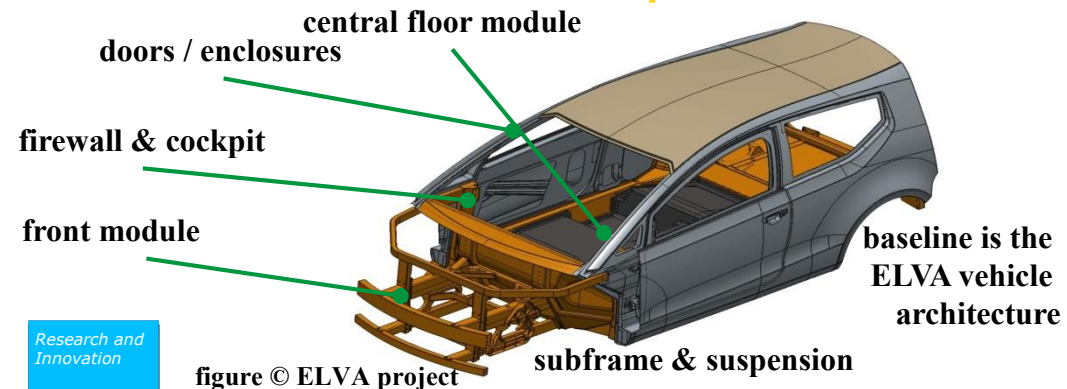

Mission:

The project targets 30% reduction of fuel consumption in long-haul heavy-trucks, thanks to a suite of energy-saving technologies and solutions

Focus:

- Holistic approach to complete vehicle energy management, considering truck, semi-trailer, driver and mission as a whole.
- Demonstrate and validate sustainable fuel-saving technologies for heavy trucks.

<http://www.convenient-project.eu>

Coordinator: Centro Ricerche Fiat
Total costs: 16.6 M€
EC contribution: 9.9 M€
Start date: November 2012
Duration: 36 Months



Research Topics and results:

- Electric Hybrid transmission integration study
- Electrified auxiliaries development
- Dual level cooling system and Flat Heat Exchangers
- Active and passive aerodynamics devices for truck-semitrailer combination
- Holistic Energy Management at vehicle level

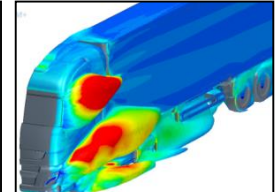
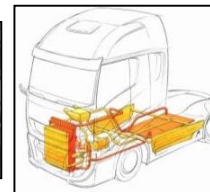

Mission:

Development of an innovative low rolling resistance truck tyre concept in combination a simulation tool box to assess tyre performance in function of material and road parameters

Focus:

- Development of new tread patterns and of advanced compounds
- Integration in tyres of developed innovative features and assessment of tyre performance through fleet tests
- Virtual analytical tool for optimization of trucks fuel consumption

Coordinator: Goodyear S.A.
Total costs: 3.6 M€
EC contribution: 2.4 M€
Start date: 01/11/2012
Duration: 36 months



Research Topics and results:

- **New tread patterns: new design, new technologies and new processing**
- **New tools for friction coefficient, abrasability determination and for fatigue testing**
- **New compounds development: functionalized NR and BR, new CB grades and CNTs**
- **Analysis of tyre performance vs pavements parameters**
- **New methodology for tyre deflection measurement**
- **Evaluation of the tyre performance for a given usage by virtual measurement**



Over 30 EGCI projects @ DG CONNECT (+ 4 CIP projects)

Electric Powertrains



Source: ODIN

Battery Management

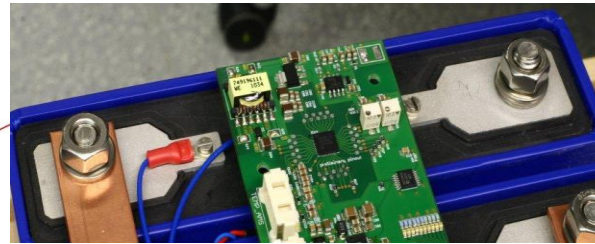

Source: ESTRELIA

Vehicle-to-Grid

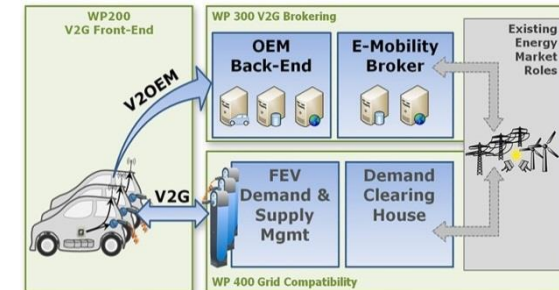

Source: e-DASH

Vehicle Dynamics

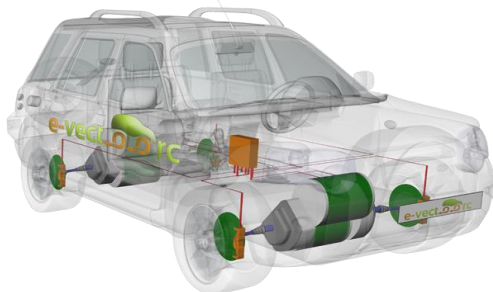

Source: E-VECTOORC

E/E Architectures



Source: OpEnR

Coordination & Support

SMART EV·VC

Source: Smart EV-VC



EGVI

European Green
Vehicles Initiative

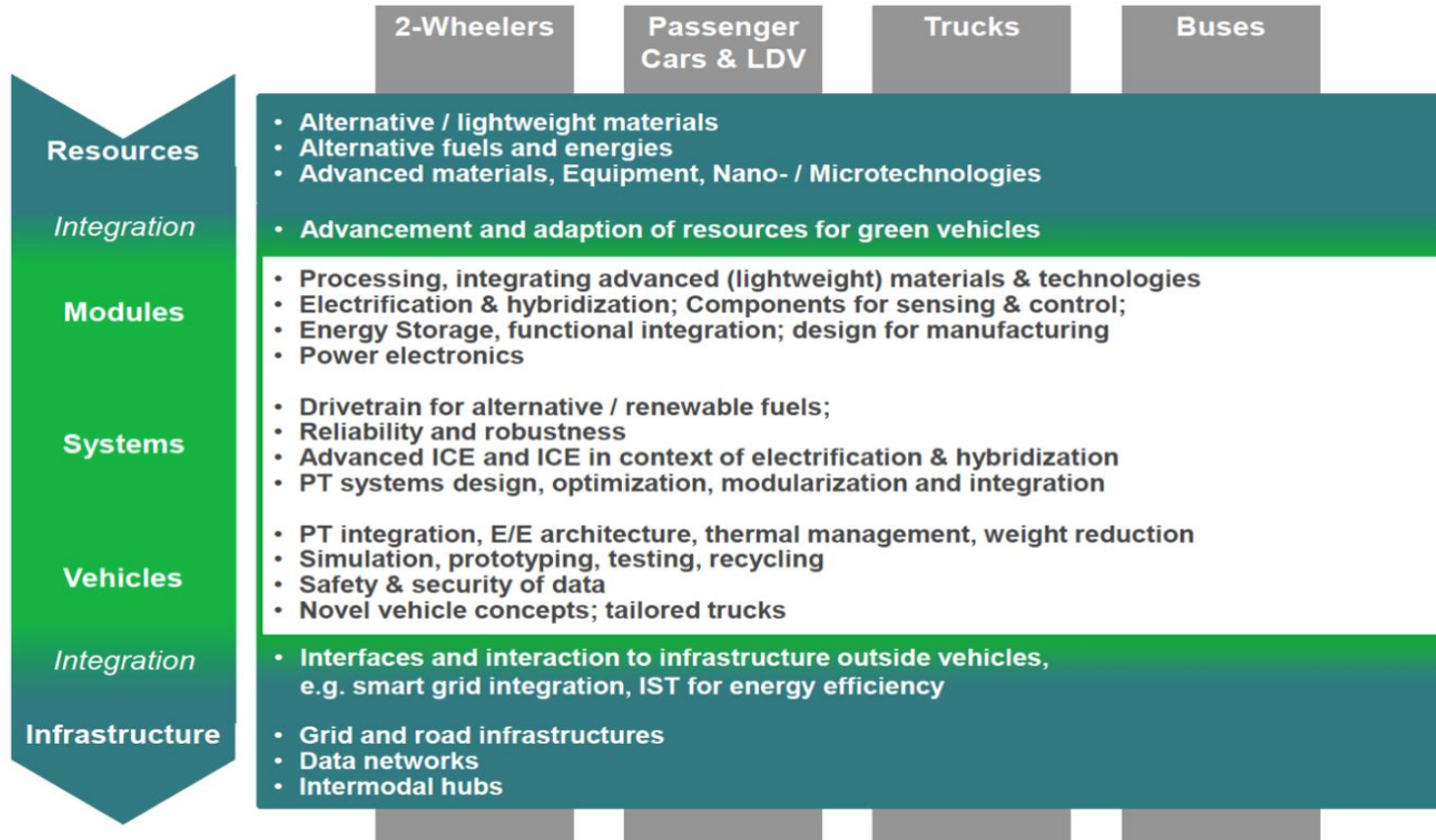

EGVI Roadmap

EGVI PPP in Work Programme 2015

GV6: Powertrain control for heavy-duty vehicles with optimised emissions

RTD

GV.8: Electric vehicles' enhanced performance and integration into the transport system and the grid

CNECT



Topic GV.8-2015

"Electric vehicles' enhanced performance and integration into the transport system and the grid"

Another 7 topics in total called for 2014/2015:

- **GV.1-2014 Next generation of competitive Li-ion batteries**
- **GV.2-2014 Optimised & systematic energy management in EV**
- **GV.3-2014 Future NG powertrains & components for cars and vans**
- **GV.4-2014 Hybrid light & heavy duty vehicles**
- **GV.5-2014 Electric two-wheelers & new light vehicle concepts**
- **GV.6-2015 Powertrain control for heavy duty vehicles with optimised emissions**
- **GV.7-2014 Future NG powertrains & components for heavy duty vehicles**



EGVI
European Green
Vehicles Initiative



Topic GV.6-2015

Major challenges:

- **Reducing real driving emissions and consumption of heavy duty road haulage**
- **These performances are closely intertwined and linked with the vehicle configuration and operating conditions.**
- **New means of flexible and global engine and emissions control can optimise the potential utilisation of individual systems.**



Topic GV.6-2015

Proposals should address the following actions:

- **Optimise the control of powertrains taking into account specific transportation tasks.**
- **Exploit on board information provided by navigation systems (i.e. topography and slopes on the chosen route), emission sensors (On Board Diagnosis/On Board Measuring system), engine, after treatment, transmission, electronics and actuators state .**
- **Integrate with other data such as transport assignment (total weight, vehicle configuration, etc.) and real time traffic and weather conditions.**

All performance to be validated through a demonstrator.



Topic GV.6-2015

Expected impact:

- **The resulting technology should deliver a global optimum for consumption (for both fuel, electric energy and other consumables related to emission control such as urea or ammonia) and noxious emissions on each mission, i.e. :**
 - **A reduction of fuel consumption of at least 20% on the same vehicle with conventional control should be demonstrated comparatively,**
 - **Emissions not exceeding Real Driving Emissions limits set by the established Euro VI procedures.**

Funding scheme: Innovation Actions

Budget: Indicatively 5-7M€



Topic GV.8-2015

Major challenges:

- **Limited driving range – biggest deployment challenge; redesign of E&E architecture and components to achieve:**
 - *increased efficiency and range*
 - *transition to FEV*
- **BMS is fundamental for electrified vehicle performance, energy efficiency & range, safety, battery life & reliability.**
- **ICT is providing:**
 - *better range prediction & offering personalised options & services to the driver*
 - *supporting recharging or high-powered fast recharging coordinated with the local electric grid*



Topic GV.8-2015

Proposals should address one of the following domains, and could include interfaces between them:

- **EV concepts featuring a complete revision of the E&E architecture to reduce complexity, the number of components & interconnections, while improving energy efficiency, functionality & modularity**
 - *May be supported by drive-by-wire, wireless communication, advanced energy storage*
 - *Should address safety, security, reliability & robustness, including EM compatibility*
 - *Should pursue a high degree of standardisation, covering the entire EV value chain*



Topic GV.8-2015

Proposals should address one of the following domains, and could include interfaces between them:

- ***BMS research focused on a combination of:***
 - ***Novel BMS designs with improved thermal management, power density and life time, safety & reliability***
 - ***Improved modelling & simulation tools for BMS improvement***
 - ***Standardisation of BMS components & interfaces***
 - ***Test methodologies & procedures to evaluate the functional safety, reliability & lifetime of battery systems***



Topic GV.8-2015

Proposals should address one of the following domains, and could include interfaces between them:

- **Integration of the overall cycle of EV energy mgt into a comprehensive EV battery & ICT-based re-charging system mgt**
- ***Digital support for EVs***
 - ***service provision based on wireless / power line communication interfaces; roaming management, energy consumption & supply; cost aspects***
- ***Interoperability of EVs with the communication infrastructure and electricity grid***
 - ***regarding locally deployed smart-grid & smart-metering systems; investigating operational issues***

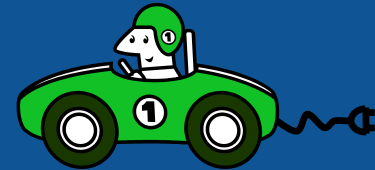

Topic GV.8-2015

Expected impact:

- ***Improvements in the cost-performance ratio of EV***
- ***Enhancements to vehicle range and/or weight, battery life and reliability without compromising on safety***
- ***Standardised BMS components and interfaces***
- ***Progress on ICT-based technologies for coordinated EV recharging.***
- ***Improved attractiveness of EVs, achieved through seamless energy management (spanning the entire cycle from re-charging spot selection/reservation to plug-out after re-charging).***
- ***Contributions to standardisation, strengthening competitiveness of the EU industry***

Funding schemes: Research and Innovation Actions

Budget: Call closing 15-10-2015 , 20M€



HORIZON 2020

Thank you for your attention

RTD: maurizio.maggiore@ec.europa.eu

CONNECT: stefanos.gouvras@ec.europa.eu

More information:

HORIZON 2020:

<http://ec.europa.eu/research/participants/portal/desktop/en/home.html>

Contractual Public-Private Partnerships in research and innovation:

http://ec.europa.eu/research/industrial_technologies/ppp-in-research_en.html